

Model 7402 Thermocouple Scanner Card

Instruction Manual

Contains Operating and Servicing Information

KEITHLEY

WARRANTY

Keithley Instruments, Inc. warrants this product to be free from defects in material and workmanship for a period of 1 year from date of shipment.

Keithley Instruments, Inc. warrants the following items for 90 days from the date of shipment: probes, cables, rechargeable batteries, diskettes, and documentation.

During the warranty period, we will, at our option, either repair or replace any product that proves to be defective.

To exercise this warranty, write or call your local Keithley representative, or contact Keithley headquarters in Cleveland, Ohio. You will be given prompt assistance and return instructions. Send the product, transportation prepaid, to the indicated service facility. Repairs will be made and the product returned, transportation prepaid. Repaired or replaced products are warranted for the balance of the original warranty period, or at least 90 days.

LIMITATION OF WARRANTY

This warranty does not apply to defects resulting from product modification without Keithley's express written consent, or misuse of any product or part. This warranty also does not apply to fuses, software, non-rechargeable batteries, damage from battery leakage, or problems arising from normal wear or failure to follow instructions.

THIS WARRANTY IS IN LIEU OF ALL OTHER WARRANTIES, EXPRESSED OR IMPLIED, INCLUDING ANY IMPLIED WARRANTY OF MERCHANTABILITY OR FITNESS FOR A PARTICULAR USE. THE REMEDIES PROVIDED HEREIN ARE BUYER'S SOLE AND EXCLUSIVE REMEDIES.

NEITHER KEITHLEY INSTRUMENTS, INC. NOR ANY OF ITS EMPLOYEES SHALL BE LIABLE FOR ANY DIRECT, INDIRECT, SPECIAL, INCIDENTAL OR CONSEQUENTIAL DAMAGES ARISING OUT OF THE USE OF ITS INSTRUMENTS AND SOFTWARE EVEN IF KEITHLEY INSTRUMENTS, INC., HAS BEEN ADVISED IN ADVANCE OF THE POSSIBILITY OF SUCH DAMAGES. SUCH EXCLUDED DAMAGES SHALL INCLUDE, BUT ARE NOT LIMITED TO: COSTS OF REMOVAL AND INSTALLATION, LOSSES SUSTAINED AS THE RESULT OF INJURY TO ANY PERSON, OR DAMAGE TO PROPERTY.



Keithley Instruments, Inc. • 28775 Aurora Road • Cleveland, OH 44139 • 440-248-0400 • Fax: 440-248-6168 • <http://www.keithley.com>

BELGIUM:	Keithley Instruments B.V.	Bergensesteenweg 709 • B-1600 Sint-Pieters-Leeuw • 02/363 00 40 • Fax: 02/363 00 64
CHINA:	Keithley Instruments China	Yuan Chen Xin Building, Room 705 • 12 Yumin Road, Dewai, Madian • Beijing 100029 • 8610-62022886 • Fax: 8610-62022892
FRANCE:	Keithley Instruments Sarl	B.P. 60 • 3, allée des Garays • 91122 Palaiseau Cédex • 01 64 53 20 20 • Fax: 01 60 11 77 26
GERMANY:	Keithley Instruments GmbH	Landsberger Strasse 65 • D-82110 Germering • 089/84 93 07-40 • Fax: 089/84 93 07-34
GREAT BRITAIN:	Keithley Instruments Ltd	The Minster • 58 Portman Road • Reading, Berkshire RG30 1EA • 0118-9 57 56 66 • Fax: 0118-9 59 64 69
INDIA:	Keithley Instruments GmbH	Flat 2B, WILOCRISSA • 14, Rest House Crescent • Bangalore 560 001 • 91-80-509-1320/21 • Fax: 91-80-509-1322
ITALY:	Keithley Instruments s.r.l.	Viale S. Gimignano, 38 • 20146 Milano • 02/48 30 30 08 • Fax: 02/48 30 22 74
NETHERLANDS:	Keithley Instruments B.V.	Postbus 559 • 4200 AN Gorinchem • 0183-635333 • Fax: 0183-630821
SWITZERLAND:	Keithley Instruments SA	Kriesbachstrasse 4 • 8600 Dübendorf • 01-821 94 44 • Fax: 01-820 30 81
TAIWAN:	Keithley Instruments Taiwan	1 Fl. 85 Po Ai Street • Hsinchu, Taiwan, R.O.C. • 886-3572-9077 • Fax: 886-3572-9031

Model 7402 Thermocouple Scanner Card Instruction Manual

© 1987, Keithley Instruments, Inc.
Test Instrumentation Group
All rights reserved.
Cleveland, Ohio, U.S.A.
April 1987, First Printing
Document Number: 7402-901-01 Rev. A

Safety Precautions

The following safety precautions should be observed before using this product and any associated instrumentation. Although some instruments and accessories would normally be used with non-hazardous voltages, there are situations where hazardous conditions may be present.

This product is intended for use by qualified personnel who recognize shock hazards and are familiar with the safety precautions required to avoid possible injury. Read the operating information carefully before using the product.

The types of product users are:

Responsible body is the individual or group responsible for the use and maintenance of equipment, for ensuring that the equipment is operated within its specifications and operating limits, and for ensuring that operators are adequately trained.

Operators use the product for its intended function. They must be trained in electrical safety procedures and proper use of the instrument. They must be protected from electric shock and contact with hazardous live circuits.

Maintenance personnel perform routine procedures on the product to keep it operating, for example, setting the line voltage or replacing consumable materials. Maintenance procedures are described in the manual. The procedures explicitly state if the operator may perform them. Otherwise, they should be performed only by service personnel.

Service personnel are trained to work on live circuits, and perform safe installations and repairs of products. Only properly trained service personnel may perform installation and service procedures.

Exercise extreme caution when a shock hazard is present. Lethal voltage may be present on cable connector jacks or test fixtures. The American National Standards Institute (ANSI) states that a shock hazard exists when voltage levels greater than 30V RMS, 42.4V peak, or 60VDC are present. **A good safety practice is to expect that hazardous voltage is present in any unknown circuit before measuring.**

Users of this product must be protected from electric shock at all times. The responsible body must ensure that users are prevented access and/or insulated from every connection point. In some cases, connections must be exposed to potential human contact. Product users in these circumstances must be trained to protect themselves from the risk of electric shock. If the circuit is capable of operating at or above 1000 volts, **no conductive part of the circuit may be exposed.**

As described in the International Electrotechnical Commission (IEC) Standard IEC 664, digital multimeter measuring circuits (e.g., Keithley Models 175A, 199, 2000, 2001, 2002, and 2010) are Installation Category II. All other instruments' signal terminals are Installation Category I and must not be connected to mains.

Do not connect switching cards directly to unlimited power circuits. They are intended to be used with impedance limited sources. NEVER connect switching cards directly to AC mains. When connecting sources to switching cards, install protective devices to limit fault current and voltage to the card.

Before operating an instrument, make sure the line cord is connected to a properly grounded power receptacle. Inspect the connecting cables, test leads, and jumpers for possible wear, cracks, or breaks before each use.

For maximum safety, do not touch the product, test cables, or any other instruments while power is applied to the circuit under test. ALWAYS remove power from the entire test system and discharge any capacitors before: connecting or disconnecting cables or jumpers, installing or

removing switching cards, or making internal changes, such as installing or removing jumpers.

Do not touch any object that could provide a current path to the common side of the circuit under test or power line (earth) ground. Always make measurements with dry hands while standing on a dry, insulated surface capable of withstanding the voltage being measured.

The instrument and accessories must be used in accordance with its specifications and operating instructions or the safety of the equipment may be impaired.

Do not exceed the maximum signal levels of the instruments and accessories, as defined in the specifications and operating information, and as shown on the instrument or test fixture panels, or switching card.

When fuses are used in a product, replace with same type and rating for continued protection against fire hazard.

Chassis connections must only be used as shield connections for measuring circuits, NOT as safety earth ground connections.

If you are using a test fixture, keep the lid closed while power is applied to the device under test. Safe operation requires the use of a lid interlock.

If a  screw is present, connect it to safety earth ground using the wire recommended in the user documentation.

The  symbol on an instrument indicates that the user should refer to the operating instructions located in the manual.

The  symbol on an instrument shows that it can source or measure 1000 volts or more, including the combined effect of normal and common mode voltages. Use standard safety precautions to avoid personal contact with these voltages.

The **WARNING** heading in a manual explains dangers that might result in personal injury or death. Always read the associated information very carefully before performing the indicated procedure.

The **CAUTION** heading in a manual explains hazards that could damage the instrument. Such damage may invalidate the warranty.

Instrumentation and accessories shall not be connected to humans.

Before performing any maintenance, disconnect the line cord and all test cables.

To maintain protection from electric shock and fire, replacement components in mains circuits, including the power transformer, test leads, and input jacks, must be purchased from Keithley Instruments. Standard fuses, with applicable national safety approvals, may be used if the rating and type are the same. Other components that are not safety related may be purchased from other suppliers as long as they are equivalent to the original component. (Note that selected parts should be purchased only through Keithley Instruments to maintain accuracy and functionality of the product.) If you are unsure about the applicability of a replacement component, call a Keithley Instruments office for information.

To clean an instrument, use a damp cloth or mild, water based cleaner. Clean the exterior of the instrument only. Do not apply cleaner directly to the instrument or allow liquids to enter or spill on the instrument. Products that consist of a circuit board with no case or chassis (e.g., data acquisition board for installation into a computer) should never require cleaning if handled according to instructions. If the board becomes contaminated and operation is affected, the board should be returned to the factory for proper cleaning/servicing.

7402 SPECIFICATIONS

CHANNELS PER CARD: 9 plus temperature reference.

CONTACT CONFIGURATION: 2 pole form A, with common guard.

ISOTHERMAL BLOCK:

Temperature Offset: $\pm 0.05^{\circ}\text{C}$ maximum from HI to LO of any channel or between any two adjacent channels in a column of the isothermal block. $\pm 0.1^{\circ}\text{C}$ maximum between any two terminals on the isothermal block. Maximum additional dynamic offset due to 10°C step change in environment; $\pm 0.1^{\circ}\text{C}$ after 1 hour settling.

Connector type: Screw terminals, No. 18 AWG wire maximum.

TEMPERATURE REFERENCE:

Type: Semiconductor, temperature dependent current source.

Output: $+200\mu\text{V}/^{\circ}\text{C}$, ($+54.63\text{mV}$ @ 0°C).

Accuracy: $\pm 0.25^{\circ}\text{C}$ (10° - 35°C), $\pm 0.50^{\circ}\text{C}$ (0° - 10°C and 35° - 50°C).

RELAY:

Drive Current: 12mA per relay (typical).

Actuation Time: $< 5\text{ms}$, exclusive of mainframe.

Contact Offset Voltage: $< 1\mu\text{V}$.

Maximum Signal Level: 42V, 100mA, 2VA (non-inductive load only).

Contact Life: $> 10^6$ closures (dry circuit), $> 10^6$ at maximum signal level.

Contact Resistance: $< 0.7\Omega$ initial ($< 2\Omega$ to rated contact life).

ISOLATION:

Channel: $> 10^9\Omega$, $< 10\text{pF}$.

Input: $> 10^9\Omega$, $< 150\text{pF}$.

Common Mode Voltage: 200V peak.

ENVIRONMENT:

Operating: 0° - 50°C , 0% to 70% relative humidity up to 35°C ; linearly derate 3% RH/ $^{\circ}\text{C}$, 35° - 50°C .

Storage: -25° to $+65^{\circ}\text{C}$.

DIMENSIONS, WEIGHT: 32mm high \times 114mm wide \times 272mm long ($1\frac{1}{4}$ in. \times $4\frac{1}{2}$ in. \times $10\frac{3}{4}$ in.). Net weight 0.64kg (1 lb. 6.5 oz.).

Specifications subject to change without notice.

TABLE OF CONTENTS

SECTION 1 — GENERAL INFORMATION

1.1	Introduction	1
1.2	Warranty Information	2
1.3	Manual Addenda	2
1.4	Safety Symbols and Terms	2
1.5	Unpacking and Inspection	3
1.6	Specifications	3

SECTION 2 — OPERATION

2.1	Introduction	5
2.2	Safety Precautions	5
2.3	Wiring and Installation	5
2.4	Operating Notes	8
2.5	Thermocouple Measurements	9
2.6	Measurement Procedure	10
2.7	Switch Terminology	12

SECTION 3 — SERVICING INFORMATION

3.1	Introduction	29
3.2	Handling and Cleaning	30
3.3	Principles of Operation	30
3.4	Recommended Test Equipment	31
3.5	Calibration	33
3.5.1	Calibration with Thermocouple Wire	33
3.5.2	Calibration with Thermistor Probe	35
3.6	Performance Verification	37
3.7	Isolation Tests	39
3.7.1	Channel Isolation	39
3.7.2	Input Isolation, Common Mode	41

SECTION 4 — REPLACEABLE PARTS

4.1	Introduction	43
4.2	Replaceable Parts	43
4.3	Ordering Information	43
4.4	Factory Service	43
4.5	Component Layout and Schematic Diagram	44

LIST OF TABLES

SECTION 2 — OPERATION

2-1	NBS Quartic Coefficients for Types S, R, E, J, K, and T	14
-----	--	----

SECTION 3 — SERVICING INFORMATION

3-1	Recommended Test Equipment	32
-----	----------------------------------	----

SECTION 4 — REPLACEABLE PARTS

4-1	Model 7402 Parts List	44
-----	-----------------------------	----

LIST OF ILLUSTRATIONS

SECTION 2 — OPERATION

2-1	Connections and Wire Routing	7
2-2	Multiple Channel Analog Connections	9
2-3	Thermocouple Measurement	10
2-4	Switch Terminology	13

SECTION 3 — SERVICING INFORMATION

3-1	Calibration with Thermocouple Wire	34
3-2	Calibration with Thermistor Probe	36
3-3	Performance Verification	38
3-4	Channel Isolation	40
3-5	Common Mode Input Isolation	42

SECTION 4 — REPLACEABLE PARTS

4-1	Model 7402 Component Location	45
4-2	Model 7402 Schematic Diagram	47

SECTION 1

GENERAL INFORMATION

1.1 INTRODUCTION

The Model 7402 Thermocouple Scanner Card is field-installable in the Model 740 scanning thermometer and the Models 705 and 706 scanner mainframes. Since it combines the functions of a thermocouple scanner and a uniform temperature reference, it is especially useful for scanning thermocouples.

NOTE

For proper operation of the Model 7402 card, the Model 740 must have software revision B.0 or higher. Use of earlier software will give erroneous temperature readings.

NOTE

Upon power up, the Model 740 scanning thermometer checks for card types (Models 7402 or 7057A thermocouple scanner card) present in its slot and any slaved scanner mainframe. The two card types can be intermixed in a system if the Model 740 has revision B.0 or later software.

The input terminals are set in an isothermal block to minimize temperature differences. An integrated circuit temperature transducer within the the isothermal block senses the reference (cold) junction temperature and converts it to a proportional current. The temperature of the heat sink is used to calculate the corrected thermocouple output. The output voltages of each thermocouple must be converted to temperature ($^{\circ}\text{C}$ or $^{\circ}\text{F}$) using appropriate thermocouple tables or polynomial equations.

In addition, any channel can be used for monitoring low-level signals. The Model 7402 uses 2-pole Form A contacts for switching of signals up to 42V, 100mA, 2VA (non-inductive load only).

1.2 WARRANTY INFORMATION

Warranty information is stated on the inside front cover of this manual. If there is a need for service, contact the Keithley representative or authorized repair facility in your area. Check the back cover for addresses. The service form supplied at the end of the manual should be used to provide the service facility with information concerning any difficulty.

1.3 MANUAL ADDENDA

Product improvements or changes to this manual will be explained on an addendum included with the manual. It is recommended that this information be incorporated immediately into the appropriate places in the manual.

If an additional instruction manual is required, order the manual package (Keithley Part Number 7402-901-00). The manual package includes an instruction manual and all pertinent addenda.

1.4 SAFETY SYMBOLS AND TERMS

The symbol  on the card denotes that the user should refer to the operating instructions.

The **WARNING** used in this manual explains dangers that could result in personal injury or death.

The **CAUTION** used in this manual explains hazards that could damage the card.

1.5 UNPACKING AND INSPECTION

The Model 7402 was inspected both electrically and mechanically before shipment. Upon receiving the Model 7402, unpack all items from the shipping carton and check for any obvious damage that may have occurred during transit. Report any damage to the shipping agent. Retain and use the original packaging materials in case reshipment is necessary. The following items are shipped with every Model 7402:

Model 7402 Thermocouple Scanner Card
Model 7402 Instruction Manual

1.6 SPECIFICATIONS

Detailed specifications of the Model 7402 precede the Table of Contents of this manual.

SECTION 2 OPERATION

2.1 INTRODUCTION

This section describes using the Model 7402 card with the Model 740 System Scanning Thermometer and the Models 705/706 Scanners.

2.2 SAFETY PRECAUTIONS

WARNING

User supplied lethal voltages may be present on connectors or PC board. Turn off all power and discharge stored energy in external circuitry before making or breaking connections.

1. Do not exceed the Model 7402s maximum voltages of $\pm 200V$ peak terminal to terminal or terminal to chassis.
2. Make sure the scanning thermometer and scanner mainframes are grounded through an earth grounded receptacle before operation.
3. Inspect the insulation of the thermocouple wires for wear, cracks, or breaks. If any defects are found, replace the thermocouple assembly.

2.3 WIRING AND INSTALLATION

Each of the ten channels on the Model 7402 has a double-pole single-throw (DPST), normally open (NO) relay. The card can be used to connect one of nine external signals to the output. (Channel 1 monitors the temperature of the isothermal block.)

NOTE

Because of the high impedance of the board, take special care when handling and using to prevent degradation of performance. Handle the board by the edges to avoid contaminating it with dirt, body oil, etc. For cleaning instructions, see paragraph 3.2.

CAUTION

Leave the Model 7402 in its anti-static bag until ready for installation to avoid possible static damage.

Perform the following procedure to wire thermocouples to the Model 7402:

1. Make sure the Model 740 (or Models 705/706) power is off, the line cord is disconnected, and any thermocouples are clear of external voltages.
2. On the Model 7402, connect the thermocouple positive lead to the channel HI screw terminal and the negative lead (red insulation) to the channel LO screw terminal. See Figure 2-1. The screw terminals accept #18 to #36 AWG (0.044 to 0.005 inch) wire. Do not let the wire get under the overlay as it might short to the isothermal block.

WARNING

When using a scanner card such as the Model 7402, never connect a thermocouple directly to the Model 740 input card. Personal injury or damage to the instrument could result.

3. Connect wires to the output HI and LO screw terminals of the Model 7402.
4. Remove one screw from the cable clamp and route the wires through the clamp. Reassemble and tighten the clamp to serve as a strain relief.
5. Insert the Model 7402 into the Model 740 (or 705/706) while connecting the 7402 output wires to the input terminals of the 740 input card. Be sure to observe the proper polarity.

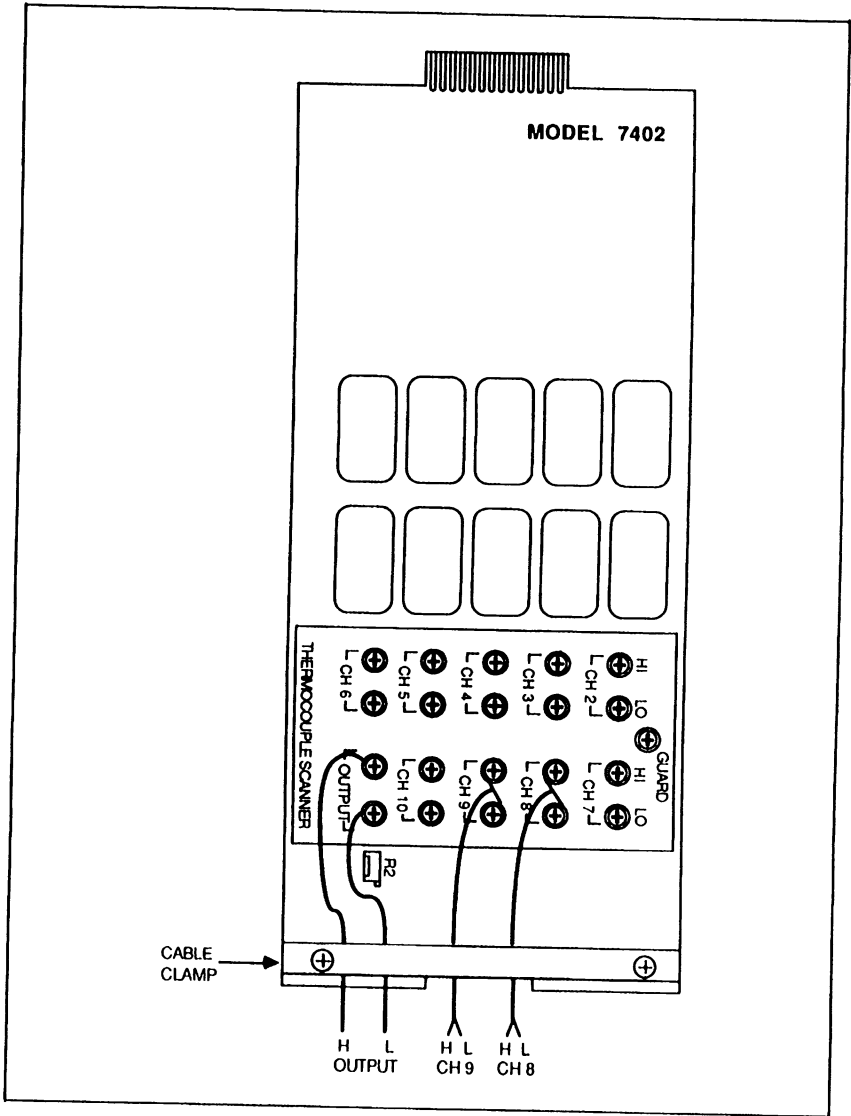

Figure 2-1. Connections and Wire Routing

6. If using Models 705/706 scanners, power up and program each one to be a slave.
7. Connect the Model 740 to the AC line and turn on the 740.

NOTE

Refer to the Model 740 or scanner mainframe instruction manual for complete details.

2.4 OPERATING NOTES

1. Since the Model 7402 is a 10-channel card, set the Models 705 and 706 scanners to the 2-pole mode. In the 2-pole mode, each scanner channel controls one channel on one 10-channel card.
2. Every time a channel is selected and allowed to stabilize, the channel has the same thermal offset (within a few hundred nanovolts). This offset can be accounted for in the measurement and subtracted from each reading to get a more precise measurement.
3. A guard surrounds all signal paths and is connected to the isothermal block surrounding the input terminals.
4. The relay switching time includes a $50\mu\text{sec}$ time interval between release and operate conditions. The actuation time is less than 5msec .
5. Reactances in the system cause transients during switching.
6. For systems using two or more Model 7402s, the output HI and LO connections should be made with continuous copper wires. This ensures that the number of copper-to-copper junctions is minimized and therefore unnecessary thermal effects are avoided. Figure 2-2 shows the method of continuous board-to-board connections.

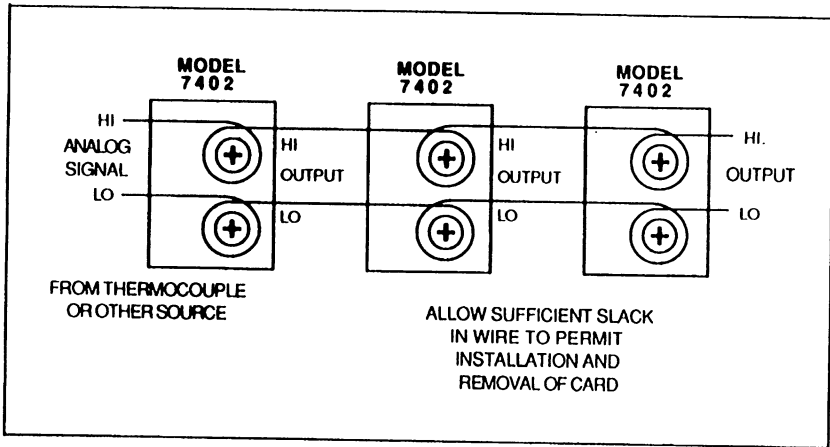

Figure 2-2. Multiple Channel Analog Connections

2.5 THERMOCOUPLE MEASUREMENTS

A thermocouple is a junction formed between two dissimilar metals. If the temperature of the thermocouple junction connected to channel 2 is T_2 , a voltage E_2 is developed between leads A and B as shown in Figure 2-3. When connected to a voltmeter, two more junctions (C and D) are formed with the meter terminals, which are usually copper. The measured voltage is proportional to the difference between temperatures T_2 and T_1 .

To determine the difference, the thermoelectric properties of the thermocouple are needed. Data is available to determine the voltage versus temperature relationship based on a reference temperature (T_1) of 0°C . Thus, if the thermocouple-to-copper junctions were maintained at 0°C , it would be possible to determine T_2 by referring to the Thermocouple Reference Tables*, which give temperature as a function of the meter reading V_2 . Since these junctions are not 0°C , a voltage E_1 is introduced, where $V_2 = E_2 - E_1$.

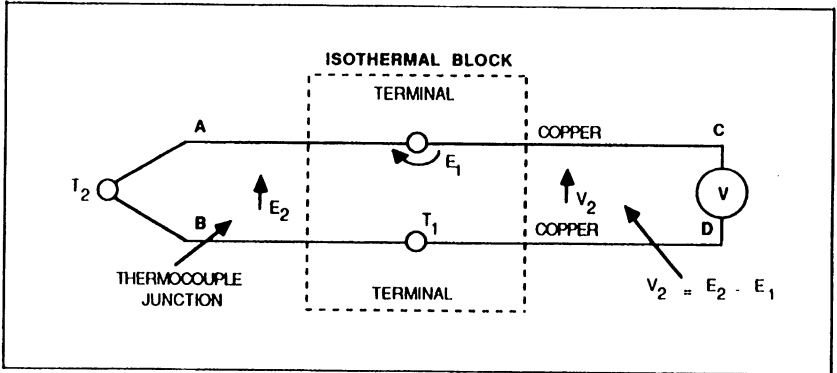

Figure 2-3. Thermocouple Measurement

2.6 MEASUREMENT PROCEDURE

The temperature of a thermocouple junction is determined by the following summarized procedure:

- Measure the reference voltage (V_1).
- Calculate the reference temperature (T_1).
- Determine the reference correction voltage (E_1).
- Measure the thermocouple voltage (V_2).
- Calculate the thermocouple correction voltage (E_2).
- Determine the thermocouple temperature (T_2).

The complete step-by-step procedure follows:

1. Measure the reference voltage (V_1 , in millivolts) and calculate the reference temperature (T_1 , in $^{\circ}\text{C}$) where:

$$T_1 = (V_1 \times 5 \times 10^3) - (273.15)$$

2. Determine the reference correction voltage (E_1 , in microvolts), either from the Thermocouple Reference Tables* or by the calculation**:

$$E_1 = a_0 + a_1T_1 + a_2T_1^2 + a_3T_1^3 + a_4T_1^4$$

The coefficients a_0 through a_4 depend on the thermocouple type and temperature range under consideration.

3. Measure the thermocouple voltage (V_2) at the channel output. Convert to microvolts.
4. Calculate the thermocouple correction voltage (E_2 , in microvolts) by adding the reference correction voltage (E_1) to the thermocouple voltage (V_2):

$$E_2 = V_2 + E_1$$

5. Determine the thermocouple temperature (T_2 , in °C), either from the Thermocouple Reference Tables* or by the calculation**:

$$T_2 = a_0 + a_1E_2 + a_2E_2^2 + a_3E_2^3 + a_4E_2^4$$

For example, consider a Type J iron-constantan thermocouple at approximately 300°C. Assume a reference temperature (T_1) of 36°C.

1. The reference voltage (Channel 1) will be:

$$V_1 = (T_1 + 273.15)/5000 = 61.83\text{mV}$$

2. Using NBS Monograph 125, the reference correction voltage (E_1) for a Type J thermocouple is 1849.0 μV . Using the most accurate quartic approximation formula (Table 2-1) for this temperature range gives 1849.05 μV .
3. Assume the thermocouple voltage reading at Channel 2 (V_2) to be 14476.0 μV .
4. Adding E_1 to V_2 yields a thermocouple correction voltage (E_2) of 16325.0 μV .
5. Using Table A6.2.1 (NBS Monograph 125) to find the thermocouple temperature gives 300.00°C. Using the formula (Table 2-1) gives 299.995°C.

* Thermocouple Reference Tables, based on the IPTS-68 National Bureau of Standards Monograph 125. (SD Catalog No. C13.44:125)

** See also Table 2-1 which summarizes the quartic coefficients.

2.7 SWITCH TERMINOLOGY

Terms used to describe switch configurations (see Figure 2-4) are defined as follows:

1. Form A is a single pole, normally open (SPNO) switch. A 2-pole, normally open switch is called 2 Form A.
2. Form B is similar to Form A except that its contacts are normally closed (SPNC). A 2-pole, normally closed switch is called 2 Form B.
3. Form C is a single pole, double throw switch (SPDT). A 2-pole configuration is called 2 Form C.

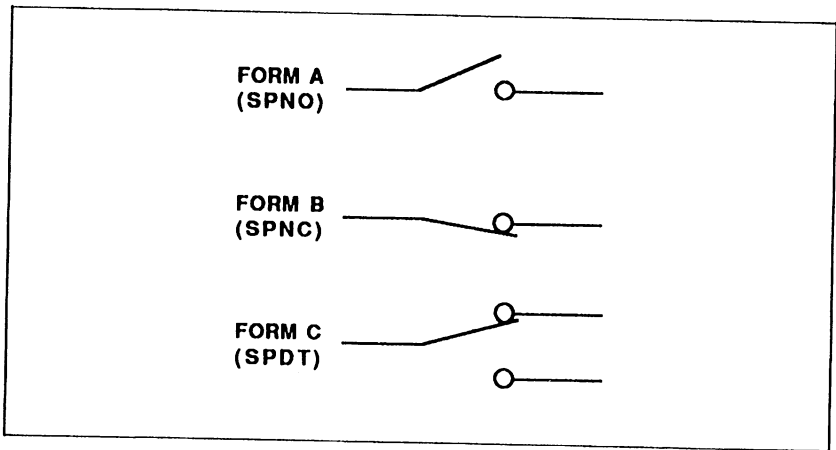

Figure 2-4. Switch Terminology

Table 2-1. NBS Quartic Coefficients for Types S,R,E,J,K and T

Type S Thermocouples: Temperature Range (°C)	a ₀		a ₁		a ₂		a ₃		a ₄		Error Range (μV) Exact-Approx.
	Argument	Exp.	Argument	Exp.	Argument	Exp.	Argument	Exp.	Argument	Exp.	
I. Quartic Equation											
- 50 to 900											- 7 to 14
0 to 1100			5.5439639	+ 0	1.0103667	- 2	- 1.0944489	- 5	4.9628963	- 9	- 16 to 12
0 to 1400			5.8791282	+ 0	7.9098118	- 3	- 6.7450002	- 6	2.5247577	- 9	- 35 to 25
0 to 1650			6.2516859	+ 0	5.8347866	- 3	- 3.4351369	- 6	9.4022202	- 10	- 55 to 35
0 to 1768			6.9554932	+ 0	4.4519908	- 3	- 1.6378513	- 6	2.4140360	- 10	- 60 to 35
400 to 1100			6.6834421	+ 0	3.9334084	- 3	- 1.0384046	- 6	3.4244511	- 11	- 7 to 5
400 to 1400			8.7228147	+ 0	6.2984907	- 4	9.0526670	- 7	- 2.9241601	- 10	- 1.6 to 1.5
400 to 1650			9.5827994	+ 0	- 1.2077351	- 3	2.5723104	- 6	- 8.3681057	- 10	- 1.8 to 1.9
400 to 1800			- 5.0061921	+ 2	- 9.7986687	- 4	2.3967559	- 6	- 7.8637971	- 11	- 0.5 to .05
1050 to 1400			1.4352322	+ 3	6.9951678	- 3	- 1.8986036	- 6	6.5006637	- 11	- 0.5 to .05
1400 to 1550			1.3054176	+ 3	6.4741403	- 3	- 1.6163524	- 6	7.9103746	- 12	- 0.5 to .05
1400 to 1650			1.8695088	+ 2	3.4664812	- 3	- 2.7553724	- 7	- 2.1606150	- 10	- 0.5 to .05
1400 to 1768			1.0863331	+ 3	3.9952876	+ 0	- 1.3595782	- 6	- 3.4675031	- 11	- 1.0 to 1.3
1666 to 1768			- 7.4180405	+ 4	- 1.9607781	- 1	8.1889566	- 5	- 1.3556030	- 8	- 0.5 to .05
Reference Junction Correction			8.2703440	+ 4	8.0243878	- 2	- 1.0633404	- 5	- 1.7212343	- 9	- 0.01 to + 0.01
0 to 50			5.3994446	+ 0	1.2467754	- 2	- 1.9934168	- 5			

Quartic approximations to the data as a function of temperature (°C) in selected temperature ranges. The expansion is of the form $E = a_0 + a_1T + a_2T^2 + a_3T^3 + a_4T^4$ where E is in microvolts and T is in degrees Celsius.

Type S Thermocouples:
Temperature
Range (°C)

I. Quartic Equation	a0		a1		a2		a3		a4		Error Range (°C)	
	Argument	Exp.	Argument	Exp.	Argument	Exp.	Argument	Exp.	Argument	Exp.	Exact-Approx.	
-50 to 900			1.6414048	-1	-2.0241757	-5	2.7849728	-9	-1.4172102	-13		-11 to 3
0 to 1100			1.5446376	-1	-1.3349067	-5	1.3626587	-9	-5.3270847	-14		-3 to 6
0 to 1400			1.4713887	-1	-9.0783455	-6	6.5660913	-10	-1.8498175	-14		-5 to 9
0 to 1650			1.4260554	-1	-7.0073775	-6	3.8881279	-10	-8.3047780	-15		-5 to 11
0 to 1768			1.4087955	-1	-6.3195007	-6	3.1267454	-10	-5.7422562	-15		-6 to 12
400 to 1100	4.1137317	+1	1.1589785	-1	-1.8642979	-6	1.2643267	-11	8.4828836	-16		-.05 to .07
400 to 1400	4.4507790	+1	1.1373998	-1	-1.3349811	-6	3.9224680	-11	2.6563405	-15		-.08 to .08
400 to 1650	4.1670535	+1	1.1543356	-1	-1.6782780	-6	-1.0845801	-11	-1.9262160	-15		-.003 to .003
1050 to 1400	-3.0638374	+1	1.4106560	-1	-4.9794442	-6	1.7334256	-10	1.8379726	-15		-2 to 2
1050 to 1650	1.2226507	+1	1.2706383	-1	-3.2873314	-6	8.3038098	-11	-1.3019379	-15		-.010 to .010
1400 to 1550	1.3866867	+2	9.3488676	-2	4.8592708	-8	6.3885209	-11	2.2896541	-15		-.0005 to .0005
1400 to 1650	1.3923740	+2	9.3267401	-2	7.7286682	-8	6.5495208	-11	2.3208160	-15		-.0005 to .0005
1400 to 1768	4.5133695	+3	-1.0046437	+0	1.0322002	-4	-4.3637046	-9	6.9361610	-14		-.13 to .10
1666 to 1768	2.3131446	+4	-5.4122671	+0	4.9347196	-4	-1.9681943	-8	2.9430179	-13		-.0005 to .0005

²Quartic approximations to the data as a function of voltage in selected temperature ranges (°C). The expansion is of the form
 $T = a_0 + a_1E + a_2E^2 + a_3E^3 + a_4E^4$ where E is in microvolts and T is in degrees Celsius.

Type R Thermocouples'
Temperature
Range (°C)

i. Quartic Equation	a0		a1		a2		a3		a4		Error Range (µV) Exact-Approx.
	Argument	Exp.	Argument	Exp.	Argument	Exp.	Argument	Exp.	Argument	Exp.	
- 50 to 900			5.4295008	+ 0	1.1446885	- 2	- 1.1295306	- 5	5.0020496	- 9	- 7 to 15
0 to 1100			5.7622558	+ 0	9.2715271	- 3	- 7.1346883	- 6	2.5877458	- 9	- 16 to 12
0 to 1400			6.1423772	+ 0	7.1515857	- 3	- 3.7539447	- 6	9.6863832	- 10	- 35 to 25
0 to 1650			6.4615269	+ 0	5.7010917	- 3	- 1.8663292	- 6	2.3636365	- 10	- 55 to 35
0 to 1768			6.5962120	+ 0	5.1559203	- 3	- 1.2365309	- 6	1.8827643	- 11	- 65 to 35
400 to 1100	- 4.0674108	+ 2	8.7490294	+ 0	1.7115155	- 3	7.5039035	- 7	- 3.0096280	- 10	- 4 to 5
400 to 1400	- 5.6047484	+ 2	9.6731111	+ 0	- 2.6894046	- 4	2.5536888	- 6	- 8.9155491	- 10	- 1.7 to 1.6
400 to 1650	- 5.4505628	+ 2	9.5942872	+ 0	- 1.2813352	- 4	2.4468512	- 6	- 8.6286756	- 10	- 2.1 to 1.8
1050 to 1400	1.6618159	+ 3	2.3048526	+ 0	8.7635426	- 3	- 2.3016819	- 6	7.4284923	- 11	- 05 to .05
1050 to 1650	1.5132838	+ 3	2.7958947	+ 0	8.1571403	- 3	- 1.9701159	- 6	6.5568864	- 12	- 05 to .05
1400 to 1550	2.4008703	+ 3	4.1604579	- 1	1.0549178	- 2	- 3.0363621	- 6	1.8540516	- 10	- 05 to .05
1400 to 1650	1.5787334	+ 3	2.6321144	+ 0	8.3100314	- 3	- 2.0332036	- 6	1.6260416	- 11	- 05 to .05
1400 to 1768	- 7.1904948	+ 4	1.9442383	+ 2	- 1.7913090	- 1	7.9264764	- 5	- 1.3187245	- 8	- 1.0 to 1.3
1666 to 1768	8.8532076	+ 4	- 1.5014129	+ 2	9.5376167	- 2	- 1.6644901	- 5	- 8.3062870	- 10	- 05 to .05
Reference Junction Correction 0 to 50			5.2891411	+ 0	1.3844426	- 2	- 2.0889531	- 5			- 0.01 to +0.01

Quartic approximations to the data as a function of temperature (°C) in selected temperature ranges. The expansion is of the form $E = a_0 + a_1 T + a_2 T^2 + a_3 T^3 + a_4 T^4$, where E is in microvolts and T is in degrees Celsius.

**Type R Thermocouples*
Temperature
Range (°C)**

I. Quartic Equation	a0		a1		a2		a3		a4		Error Range (°C) Exact-Approx.
	Argument	Exp.	Argument	Exp.	Argument	Exp.	Argument	Exp.	Argument	Exp.	
-50 to 900			1.6251434	-1	-2.0454379	-5	2.5404935	-9	-1.1767904	-13	-13 to 3
0 to 1100			1.5239494	-1	-1.3755675	-5	1.2610922	-9	-4.4281251	-14	-4 to 7
0 to 1400			1.4441607	-1	-9.5014952	-6	6.2073358	-10	-1.5622497	-14	-6 to 10
0 to 1650			1.3944190	-1	-7.4485484	-6	3.8266182	-10	-7.4517277	-15	-7 to 13
0 to 1768			1.3752883	-1	-6.7651171	-6	3.1420473	-10	-5.4254872	-15	-7 to 14
400 to 1100	4.5509556	+1	1.1284875	-1	-2.8603978	-6	8.5173702	-11	-1.1440038	-15	-4 to .04
400 to 1400	4.9160016	+1	1.1054589	-1	-2.3555046	-6	3.5276248	-11	3.3363324	-16	-08 to .08
400 to 1650	4.8343651	+1	1.1098270	-1	-2.4353890	-6	4.5164488	-11	1.8172612	-16	-10 to .12
1050 to 1400	-4.1134469	+0	1.2739464	-1	-4.3132296	-6	1.3863382	-10	-1.5263798	-15	-.02 to .002
1050 to 1650	3.7487318	+1	1.1519304	-1	-2.9827002	-6	7.4538667	-11	3.7809957	-16	-.01 to .011
1400 to 1550	8.0559850	+1	1.0442877	-1	-1.9627500	-6	3.3603790	-11	2.4513433	-16	-.0005 to .0005
1400 to 1650	1.4180146	+2	9.0181346	-2	-7.4095329	-7	-1.4487255	-11	9.4290485	-16	-.0005 to .0005
1400 to 1768	3.1759093	+3	-5.8922431	-1	5.6190639	-5	-2.1303241	-9	3.0369250	-14	-.11 to .08
1666 to 1768	1.2893437	+4	-2.6747958	+0	2.2334214	-4	-8.0565960	-9	1.0882779	-13	-.0007 to .0007

*Quartic approximations to the data as a function of voltage in selected temperature ranges (°C). The expansion is of the form $T = a_0 + a_1E + a_2E^2 + a_3E^3 + a_4E^4$, where E is in microvolts and T is in degrees Celsius.

Type B Thermocouples:
Temperature
Range (°C)

I. Quartic Equation	a ₀		a ₁		a ₂		a ₃		a ₄		Error Range (µV)	
	Argument	Exp.	Argument	Exp.	Argument	Exp.	Argument	Exp.	Argument	Exp.	Exact	Approx.
0 to 900			-2.3614224	-1	5.7496551	-3	-5.6339756	-7	-1.1808558	-10		-22 to .14
0 to 1100			-2.3693338	-1	5.7684447	-3	-5.9963692	-7	-9.7041131	-11		-.18 to .20
0 to 1400			-2.3476301	-1	5.7480761	-3	-5.7165679	-7	-1.0838193	-10		-.7 to 1.0
0 to 1650			-1.9185893	-1	5.5578879	-3	-3.3057924	-7	-2.0018428	-10		-.4 to .5
0 to 1820			-1.3749133	-1	5.3446673	-3	-9.1094186	-8	-2.8098361	-10		-.8 to .9
400 to 1100	1.3740347	+1	-3.2914888	-1	5.9766638	-3	-8.0141311	-7	-2.7203972	-11		-.05 to .05
400 to 1400	-2.5321108	+1	-9.9736579	-2	5.4976533	-3	-3.7806912	-7	-1.6156824	-10		-.5 to .5
400 to 1650	-1.1708354	+2	3.9860894	-1	4.5539656	-3	3.6623964	-7	-3.6969100	-10		-2.0 to 1.8
1050 to 1400	-9.8446259	+2	3.3670698	+0	8.2282215	-4	2.4061224	-6	-7.7901142	-10		-.05 to .05
1050 to 1650	-1.3702395	+3	4.6252371	+0	-7.0976836	-4	3.2325696	-6	-9.4548852	-10		-.05 to .05
1400 to 1550	-4.7644591	+2	2.2890832	+0	1.5749253	-3	2.2417410	-6	-7.8471224	-10		-.05 to .05
1400 to 1650	-6.4878929	+2	2.7380621	+0	1.1375302	-3	2.4305578	-6	-8.1518033	-10		-.05 to .05
Reference Junction Correction 0 to 50			-2.4673639	-1	5.9050303	-3	-1.2267180	-6				-0.01 to +0.01

*Quartic approximations to the data as a function of temperature (°C) in selected temperature ranges. The expansion is of the form $E = a_0 + a_1T + a_2T^2 + a_3T^3 + a_4T^4$ where E is in microvolts and T is in degrees Celsius.

Type B Thermocouples*
Temperature
Range (°C)

i. Quartic Equation	a ₀		a ₁		a ₂		a ₃		a ₄		Error Range (°C)	
	Argument	Exp.	Argument	Exp.	Argument	Exp.	Argument	Exp.	Argument	Exp.	Exact	Approx.
0 to 900			8.9244743	-1	-5.7447033	-4	1.8053618	-7	-1.9719121	-11		-30 to 75
0 to 1100			7.2874066	1	-3.1771931	-4	6.8254986	-8	-5.1002233	-12		-35 to 90
0 to 1400			5.7822214	-1	-1.6033309	-4	2.2187592	-8	-1.0578514	-12		-45 to 110
0 to 1650			4.9829130	-1	-1.0349686	-4	1.0792281	-8	-3.9111466	-13		-50 to 120
0 to 1820			4.6255054	-1	-8.2176262	-5	7.3717195	-9	-2.2913665	-13		-50 to 130
400 to 1100	1.8946288	+2	3.0866136	-1	-5.8100680	-5	8.2483367	-9	-4.7591774	-13		-.09 to 1.0
400 to 1400	2.0949015	+2	2.7222162	-1	-3.6930932	-5	3.6830239	-9	-1.4483702	-13		-3 to 3
400 to 1650	2.2354664	+2	2.4988761	-1	-2.7160312	-5	2.1296660	-9	-6.4220756	-14		-5 to 5
1050 to 1400	3.2188156	+2	1.8282378	-1	-1.1561743	-5	6.4320083	-10	-1.4544375	-14		.003 to .003
1050 to 1650	3.4418084	+2	1.7031473	-1	-8.9698912	-6	4.0789445	-10	-6.6410259	-15		.025 to .020
1400 to 1550	3.7140306	+2	1.5828913	-1	-7.0050689	-6	2.6714849	-10	-2.9082072	-15		-.001 to .001
1400 to 1650	3.9253848	+2	1.4979551	-1	-5.7276293	-6	1.8192801	-10	-7.8042686	-16		-.001 to .001

*Quartic approximations to the data as a function of voltage in selected temperature ranges (°C). The expansion is of the form $T = a_0 + a_1E + a_2E^2 + a_3E^3 + a_4E^4$ where E is in microvolts and T is in degrees Celsius.

Type E Thermocouples/
Temperature
Range (°C)

I. Quartic Equation	a ₀		a ₁		a ₂		a ₃		a ₄		Error Range (μV)	
	Argument	Exp.	Argument	Exp.	Argument	Exp.	Argument	Exp.	Argument	Exp.	Exact-Approx.	
-270 to 0			5.9287179	+1	7.0863783	-2	5.2421843	-5	3.8137875	-7		-5 to 5
-200 to 0			5.8754764	+1	5.7443085	-2	-5.0637772	-5	1.3960921	-7		-.5 to .4
-200 to 800			5.8043714	+1	5.6118501	-2	-5.9506594	-5	2.2327737	-8		-60 to 30
-20 to -500			5.8318735	+1	5.4292960	-2	-5.6288941	-5	2.0625928	-8		-8 to 4
0 to 400			5.8327991	+1	5.3761106	-2	-5.2870656	-5	1.5352840	-8		-3 to 4
0 to 1000			5.8734597	+1	5.0789891	-2	-4.7821793	-5	1.4659118	-8		-18 to 17
400 to 1000		+2	6.5022632	+1	3.4354900	-2	-2.9769494	-5	7.6039401	-9		-2 to 2.5
600 to 800		+3	6.7211126	+1	3.1668230	-2	-2.9237913	-5	8.1514671	-9		-.03 to .03
850 to 1000		+4	-1.6691278	+2	4.1877018	-1	-3.1228607	-4	8.5283044	-8		-.06 to .06
Reference Junction Correction 0 to 50												
			5.8637965	+1	4.6720025	-2	-1.4438022	-5				-.12 to +.24

*Quartic approximations to the data as a function of temperature (°C) in selected temperature ranges. The expansion is of the form $E = a_0 + a_1T + a_2T^2 + a_3T^3 + a_4T^4$ where E is in microvolts and T is in degrees Celsius.

**Type E Thermocouples'
Temperature
Range (°C)**

I. Quartic Equation	a ₀		a ₁		a ₂		a ₃		a ₄		Error Range (°C)	
	Argument	Exp.	Argument	Exp.	Argument	Exp.	Argument	Exp.	Argument	Exp.	Exact	Approx.
-270 to 0			2.8168878	-3	-8.5940057	-6	-1.4830918	-9	-8.7987588	-14		-9 to 6
-200 to 0			1.5726646	-2	-1.2102152	-6	-1.9577799	-10	-1.6696298	-14		-.3 to .3
-200 to 800			1.8432856	-2	-3.2311582	-7	6.9795810	-12	-5.1106952	-17		-8 to 7
-20 to 500			1.6970287	-2	-2.0630603	-7	4.6512717	-12	-4.1805785	-17		-18 to 12
0 to 400			1.7022525	-2	-2.2097240	-7	5.4809314	-12	-5.7669682	-17		-.05 to .04
0 to 1000			1.6410783	-2	-1.3560189	-7	1.8600342	-12	-8.5537337	-18		-.9 to 1.4
400 to 1000	1.9668452	+1	1.4207735	-2	-5.1844510	-8	5.6361365	-13	-1.5646343	-18		-.03 to .03
600 to 800	2.5192188	+1	1.3909529	-2	-4.7201133	-8	5.5638718	-13	-1.7775228	-18		-.0005 to .0005
850 to 1000	-7.1102114	+2	5.6554599	-2	-9.7013068	-7	9.3838146	-12	-3.3333675	-17		-.001 to .001

*Quartic approximations to the data as a function of voltage in selected temperature ranges (°C). The expansion is of the form $T = a_0 + a_1E + a_2E^2 + a_3E^3 + a_4E^4$ where E is in microvolts and T is in degrees Celsius.

Type J Thermocouples*
Temperature
Range (°C)

i. Quartic Equation	#0		#1		#2		#3		#4		Error Range (µV)	
	Argument	Exp.	Argument	Exp.	Argument	Exp.	Argument	Exp.	Argument	Exp.	Exact	Approx.
-200 to 0			5.0406743	+1	3.20209063	-2	-6.3493968	-5	2.5174022	-7		-2 to .3
-200 to 760			4.9502533	+1	3.2899022	-2	-6.9936031	-5	5.1112729	-8		-100 to 80
-200 to 1200			4.7062907	+1	2.5522650	-2	-2.2198295	-5	7.1373907	-9		-500 to 600
-20 to 500			5.0465304	+1	2.9052596	-2	-6.5668305	-5	5.3587106	-8		-1.5 to 3.0
0 to 400			5.0452389	+1	2.8409137	-2	-6.7566436	-5	5.6382040	-8		-8 to .5
0 to 760			5.1256213	+1	2.0040854	-2	-4.2235982	-5	3.2819408	-8		-24 to 36
0 to 1200			5.5961877	+1	-1.4207954	-2	3.1325181	-5	-1.5023710	-8		-210 to 160
400 to 760		+3	9.7718575	+1	-1.1658430	-2	1.3184454	-4	-4.8218788	-8		-2.5 to 2.8
400 to 1200		+3	1.8969007	+1	5.3962730	-2	-2.2171472	-5	1.8445398	-10		-110 to 100
600 to 760		+4	2.2157898	+2	-4.0418097	-1	4.2749984	-4	1.6174242	-7		-.1 to .1
760 to 1200		+4	3.9064982	+2	3.6470921	-1	-2.7029005	-4	7.2113090	-8		-11 to 11
Reference Junction Correction												
0 to 50			5.0373743	+1	3.0167011	-2	-7.4293513	-5				-.06 to +.06

*Quartic approximations to the data as a function of temperature (°C) in selected temperature ranges. The expansion is of the form $E = a_0 + a_1T + a_2T^2 + a_3T^3 + a_4T^4$ where E is in microvolts and T is in degrees Celsius.

Type J Thermocouples¹⁰
Temperature
Range (°C)

I. Quartic Equation	a ₀		a ₁		a ₂		a ₃		a ₄		Error Range (°C)	
	Argument	Exp.	Argument	Exp.	Argument	Exp.	Argument	Exp.	Argument	Exp.	Exact	Approx.
-200 to 0			1.8843850	-2	-1.2029733	-6	-2.5278593	-10	-2.5849263	-14		-4 to .5
-200 to 760			2.1155170	-2	-3.3513149	-7	1.2443997	-11	-1.5227150	-16		-6 to .7
-200 to 1200			2.1676850	-2	-2.1844464	-7	3.9094347	-12	-2.4303017	-17		-14 to .0
-20 to 500			1.9745056	-2	-1.8094256	-7	7.8777919	-12	-1.1897222	-16		-0.7 to .05
0 to 400			1.9750953	-2	-1.8542600	-7	8.3693958	-12	-1.3290568	-16		-.03 to .06
0 to 760			1.9323799	-2	-1.0306020	-7	3.7084018	-12	-5.1031937	-17		-.9 to .7
0 to 1200			1.8134974	-2	-5.6495930	-8	-2.4644023	-12	2.1141718	-17		-3 to 4
400 to 760	9.2806351	+1	5.4463817	-3	6.5254537	-7	-1.3987013	-11	9.9364476	-17		-.03 to .03
400 to 1200	-1.1075293	+2	2.8651303	-2	-2.9759175	-7	2.5945419	-12	-4.9012035	-18		-1.3 to 1.6
600 to 760	1.8020713	+2	-4.5284199	-3	1.0768294	-6	-2.1962321	-11	1.5521511	-16		-.001 to .001
760 to 1200	-6.3628680	+2	7.4068749	-2	-1.7177773	-6	2.1771293	-11	-9.9502571	-17		-.15 to .11

¹⁰Quartic approximations to the data as a function of voltage in selected temperature (°C). The expansion is of the form $T = a_0 + a_1E + a_2E^2 + a_3E^3 + a_4E^4$ where E is in microvolts and T is in degrees Celsius.

Type K Thermocouples¹¹
Temperature
Range (°C)

I. Quartic Equation	a ₀		a ₁		a ₂		a ₃		a ₄		Error Range (µV) Exact-Approx.
	Argument	Exp.	Argument	Exp.	Argument	Exp.	Argument	Exp.	Argument	Exp.	
-270 to 0			3.9575518	+1	3.10633655	-2	-9.1607986	-5	3.0066628	-8	-1.1 to 1.2
-200 to 0			3.9478446	+1	2.8256412	-2	-1.1488433	-4	-2.8153447	-8	-.06 to .05
-20 to 800			3.6762217	+1	2.4644587	-2	-4.3081963	-5	2.5127588	-8	-180 to 200
-20 to 500			4.0689640	+1	-3.2619221	-3	8.5714137	-6	-1.6812373	-9	-25 to 45
0 to 400			4.0981103	+1	-1.5692510	-4	-1.2525700	-5	3.2784725	-8	-25 to 20
0 to 1370			3.9443959	+1	5.8953822	-3	-4.2019132	-6	1.3817059	-10	-60 to 110
400 to 1000	1.3223524	+3	3.0191683	+1	2.7508912	-2	-2.4734437	-5	6.9789332	-9	-9 to 1.4
400 to 1370	-3.5456226	+1	3.8346319	+1	9.9685329	-3	-8.7444446	-6	1.7108618	-9	-12 to 11
600 to 800	2.1326086	+3	2.5608012	+1	3.7091744	-2	-3.3517324	-5	9.9607405	-9	-.05 to .07
850 to 1000	-9.0373549	+2	4.0571145	+1	9.5082149	-3	-1.0369249	-5	-3.0753213	-9	-.05 to .03
1050 to 1150	-2.5972816	+3	5.2075276	+1	-1.4578419	-2	9.4854151	-6	-3.1178779	-9	-.05 to .05
Reference Junction Correction 0 to 50			3.9448872	+1	2.4548362	-2	-9.0918433	-5			-.06 to +.14

¹¹Quartic approximations to the data as a function of temperature (°C) in selected temperature ranges. The expansion is of the form $E = a_0 + a_1T + a_2T^2 + a_3T^3 + a_4T^4$ where E is in microvolts and T is in degrees Celsius.

Type K Thermocouples:
Temperature
Range (°C)

i. Quartic Equation	a ₀		a ₁		a ₂		a ₃		a ₄		Error Range (°C)
	Argument	Exp.	Argument	Exp.	Argument	Exp.	Argument	Exp.	Argument	Exp.	
- 270 to 0			1.2329875	- 2	- 1.4434305	- 5	- 4.2824995	- 9	- 4.2028679	- 13	- 11 to 8
- 200 to 0			2.3783697	- 2	- 2.4382217	- 6	- 6.8203073	- 10	- 9.4854031	- 14	- 5 to 10
200 to 800			2.8346896	- 2	- 5.8008526	- 7	2.5720615	- 11	- 3.6813679	- 16	- 8 to 10
20 to 500			2.4363861	- 2	5.6206931	- 8	- 3.8825620	- 12	3.9120208	- 17	- 1.2 to 6
0 to 400			2.4383248	- 2	9.7830251	- 9	3.6276965	- 12	- 2.5756438	- 16	- 5 to 6
0 to 1370			2.5132785	- 2	- 6.0983423	- 8	5.5358209	- 13	9.3720918	- 18	- 2.4 to 1.2
400 to 1000		+ 1	2.9465633	- 2	- 3.1332620	- 8	6.5075717	- 12	- 3.9663834	- 17	- .02 to .02
400 to 1370		+ 0	6.2300671	- 2	- 7.8788333	- 8	1.32693743	- 12	1.5580541	- 18	- 3 to .3
600 to 800		+ 1	- 3.9480992	- 2	- 4.0905633	- 7	8.5482602	- 12	- 5.5636636	- 17	- .001 to .001
850 to 1000		+ 0	- 3.1617495	- 2	- 2.1941995	- 7	4.8782826	- 12	- 2.9316611	- 17	- .0012 to .0012
1050 to 1150		+ 2	2.3615582	- 3	8.2516607	- 7	- 1.3558849	- 11	9.1638500	- 17	- .001 to .001

¹²Quartic approximations to the data as a function of voltage in selected temperature ranges (°C). The expansion is of the form $T = a_0 + a_1E + a_2E^2 + a_3E^3 + a_4E^4$ where E is in microvolts and T is in degrees Celsius.

Type T Thermocouples¹¹
Temperature
Range (°C)

	a ₀		a ₁		a ₂		a ₃		a ₄		Error Range (μV)	
	Argument	Exp.	Argument	Exp.	Argument	Exp.	Argument	Exp.	Argument	Exp.	Exact-Approx.	
i. Quartic Equation												
-270 to 0			3.9433919	+1	6.2407452	-2	8.0773568	-5	2.6845647	-7		-9 to 7
-200 to 0			3.8749056	+1	4.5149809	-2	-4.7759448	-5	-2.5773959	-8		-14 to 13
-200 to 400			3.8621703	+1	4.5433050	-2	-3.4731838	-5	1.4661300	-8		-7 to 3.5
0 to 400			3.8468407	+1	4.6651731	-2	-3.7375793	-5	1.5959833	-8		-9 to .9
Reference Junction Correction												
0 to 50			3.8709457	+1	3.7085566	-2	5.6495520	-5				-1 to .1

¹¹Quartic approximations to the data as a function of temperature (°C) in selected temperature ranges. The expansion is of the form $E = a_0 + a_1 T + a_2 T^2 + a_3 T^3 + a_4 T^4$, where E is in microvolts and T is in degrees Celsius.

Type T Thermocouples¹⁴
Temperature
Range (°C)

I. Quartic Equation - 270 to 0 - 200 to 0 - 200 to 400 0 to 400	a ₀		a ₁		a ₂		a ₃		a ₄		Error Range (°C) Exact-Approx.
	Argument	Exp.	Argument	Exp.	Argument	Exp.	Argument	Exp.	Argument	Exp.	
			4.3553379	- 3	- 2.0325426	- 5	- 5.4720813	- 9	- 5.0865527	- 13	- 8 to 6
			2.3837090	- 2	- 2.9878839	- 6	- 7.1945810	- 10	- 1.0041943	- 13	-.3 to .3
			2.6792411	- 2	- 1.0370271	- 6	6.1330327	- 11	- 1.3988385	- 15	- 6 to 5
			2.5661297	- 2	- 6.1954869	- 7	2.2181644	- 11	- 3.5500900	- 16	- .15 to .17

¹⁴Quartic approximations to the data as a function of temperature (°C) in selected temperature ranges. The expansion is of the form $T = a_0 + a_1 E + a_2 E^2 + a_3 E^3 + a_4 E^4$ where E is in microvolts and T is in degrees Celsius.

SECTION 3

SERVICING INFORMATION

3.1 INTRODUCTION

This section describes handling and cleaning, principles of operation, and tests for calibrating and verifying the performance of the Model 7402. The tests include:

- Calibration tests - For the first test, a thermocouple is placed in a distilled water ice bath and a potentiometer on the Model 7402 is adjusted until the Model 740 reads ice-point temperature. For the second test, a calibrated thermistor probe measures the temperature of the isothermal block and a potentiometer is adjusted for the equivalent reference junction output voltage. Perform these tests in an environment of 23°C \pm 1°C up to 70% RH.
- Verification test - A test verifying the specified accuracy of card. Perform in an environment of 18°C to 28°C up to 70% RH.
- Specification tests - Two isolation tests measuring leakage currents to check for a contaminated board and possibly bad relays. Perform these tests in an environment of 10°C to 35°C up to 70% RH.

WARNING

Do not perform the procedures in this section unless you are a qualified service person. Some of the procedures may expose you to potentially lethal voltages (>30V RMS) that could result in personal injury or death if normal safety precautions are not observed.

Since air currents can cause a temperature fluctuation in the isothermal block, the card should be protected from drafts during calibration and verification.

Recommended maintenance includes inspection of the card and the card edge connector to ensure good electrical contact.

3.2 HANDLING AND CLEANING

Because of the high impedance of the board, take special care when handling and using to prevent degradation of performance. Handle the board by the edges to avoid contaminating it with dirt, body oil, etc.

CMOS and other high-impedance devices are subject to possible static discharge damage because of the high impedance levels involved. When handling such devices (indicated by * in the parts list), use the following precautions:

1. Such devices should be transported and handled only in containers specially designed to prevent or dissipate static build-up. Typically, these devices will be received in anti-static containers of plastic or foam. Keep these parts in their original containers until ready for installation.
2. Remove the devices from their protective containers only at a properly grounded work station. Also, ground yourself with a suitable wrist strap.
3. Handle the devices only by the body; do not touch the pins.
4. Any printed circuit board into which the device is to be inserted must also be grounded to the bench or table.
5. Use only anti-static de-soldering tools and grounded-tip soldering irons.

To clean the board, spray on an uncontaminated solvent, such as Freon® TMS or TE and clean with cotton swabs or a soft brush. After the solvent has been applied and is still liquid, blow-dry the board with dry-pumped nitrogen gas.

3.3 PRINCIPLES OF OPERATION

The Model 7402 circuitry can be divided into three sections: a voltage source, a temperature measurement circuit, and a relay scanner. Refer to the card schematic in Section 4.

A voltage doubler is formed by the CMOS voltage converter U1 and components C1, C13, CR1, and CR2. The output of the doubler, available at the positive end of C13, should be roughly double the input voltage. This voltage is applied to the input of U2.

U2 is a five volt regulator that provides a stable voltage source for the temperature dependent current source U3. (U3 is mounted in the isothermal block and is accessible from the bottom of the PC board.)

U3, R1, R2, and R3 form the isothermal block temperature measurement circuit. R2 is a calibration adjustment potentiometer that compensates for errors introduced by U3, R1, and R3.

C14, C15, and C16 are for high frequency bypassing.

In the relay scanner section, resistors R4 through R13 provide reduced relay coil power dissipation to minimize contact offset voltages. Capacitors C2 through C11 guarantee relay operation by providing a momentary surge of current upon a relay closure.

3.4 RECOMMENDED TEST EQUIPMENT

Table 3-1 lists recommended test equipment for the calibration, verification, and specification tests. Other test equipment may be substituted if specifications equal or exceed those stated.

NOTE

Since the Model 617 electrometer has an internal 100V source, it can be used in the V/I mode instead of the Model 614 electrometer and Model 230 voltage source.

Table 3-1. Recommended Test Equipment

Description	Specification	Mfr.	Model
Scanning Thermometer	fully calibrated	Keithley	740
Scanner Mainframe	—	Keithley	705 or 706
Extender Card	—	Keithley	7061
Voltage Source	100VDC	Keithley	230
Electrometer	1 μ A resolution	Keithley	614 or 617
Distilled water ice bath	$\pm 0.1^{\circ}\text{C}$	—	—
(Dewar flask or Thermo [®])	—	—	—
DMM (voltmeter)	1 μ V resolution	Keithley	196
DMM (ohmmeter)	100m Ω resolution	Keithley	196
Thermistor Probe	$\pm 0.005^{\circ}\text{C}$ accuracy	Thermometrics	Series CSP A207A
Power Supply	5VDC, $\pm 5.0\%$	—	—
Reference Thermometer	$\pm 0.01^{\circ}\text{C}$ with thermistor	—	—

3.5 CALIBRATION

There are two calibration procedures given here. Use the first one to establish an ice-point reference for a piece of thermocouple wire from the spool intended for the Model 7402 application. The second procedure establishes the specified accuracy of the card itself by using a calibrated thermistor probe to monitor the temperature of the isothermal block.

3.5.1 Calibration with Thermocouple Wire

This procedure compensates for errors of the reference junction circuitry and establishes a compensation factor for the offset of the particular piece of thermocouple wire. Because of an inherent error source, the thermocouple wire used in measuring the ice-point, absolute calibration accuracy cannot be guaranteed.

Assuming homogeneity of the thermocouple wire spool, errors due to thermocouple offset voltages will be significantly reduced for the entire system. For subsequent applications of this particular Model 7402 card, the same spool of wire should be used, otherwise the 7402 should be recalibrated.

1. On the Model 7402, connect the thermocouple positive lead to Channel 2 HI and the negative lead (red insulation) to Channel 2 LO. See Figure 3-1. Route the wire through the cable clamp. Also insert a small non-metallic screwdriver through the cable clamp to adjust trimmer R2.
2. Insert the Model 7402 into the Model 740 while connecting the 7402 output wires to the input terminals of the 740 input card. Be sure to observe the proper polarity.
3. Connect the Model 740 to the AC line and turn on the 740. Allow the 740 and 7402 to warm up at least one hour.
4. Fill a Dewar flask or Thermos® half full with ice cubes made from distilled water. Fill the flask with distilled water. Stir contents.
5. Place a twisted or welded thermocouple junction into volume of flask occupied by ice. Cover the flask and stir contents occasionally. Allow 20 minutes for temperature stabilization. Add more ice as necessary.

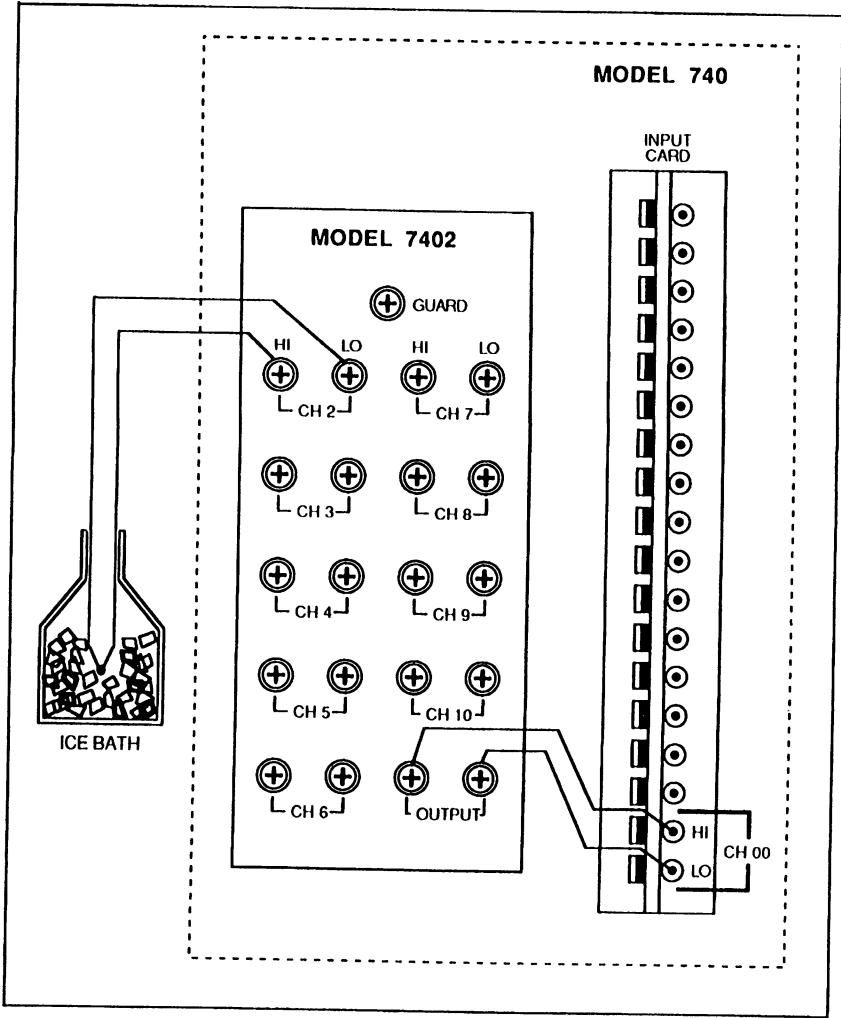

Figure 3-1. Calibration with Thermocouple Wire

6. Set the Model 740 to channel 2, °F scale (yields better resolution than °C scale), Filter OFF, Scan Enable ON, Continuous ON, and a 500mS rate.
7. Press the TYPE SELECT button twice and select OFF, press ENTER. This sets all channels off.
8. Press the TYPE SELECT button once and select a thermocouple type for channel 2 that corresponds to the thermocouple being used for calibration. Press ENTER.
9. Press the START button. This causes the 740 to scan both the active channel and the Model 7402 reference output. This provides a continuous update of the reference output and a subsequent reading conversion. (Otherwise there may be up to a 10 second delay between adjustment and update.)
10. Note the reading on the Model 740 display. If the 740 reads other than 32.0°F, adjust trimmer R2 (REF ADJ) on the Model 7402 card until the 740 reads 32.0°F ± 1 count.

3.5.2 Calibration with Thermistor Probe

This procedure requires a calibrated thermistor probe (Thermometrics Series CSP A207A or equivalent). The test can be automated with a bus controller. In general, the procedure has the following steps:

1. Set a Model 196 DMM to the 300k Ω range and let it warm up for two hours. (The short circuit current on this range is 50 μ A. Due to the self-heating effects of the thermistor probe at higher currents, do not use a lower resistance range.)
2. Set another Model 196 to the 300mVDC range and insert a 2-terminal low thermal shorting bar into the voltage inputs. Zero it after two hours and remove the shorting bar.
3. Set up the test equipment as shown in Figure 3-2.
4. Coat the probe with a thermally conductive compound and insert it into the hole at rear of the card's isothermal block.
5. Take a reading of the probe resistance when it stabilizes.
6. Using lookup tables for the CSP A207A probe, find the Celsius temperature that corresponds to the above probe resistance. This is the temperature of the isothermal block as measured by the probe.

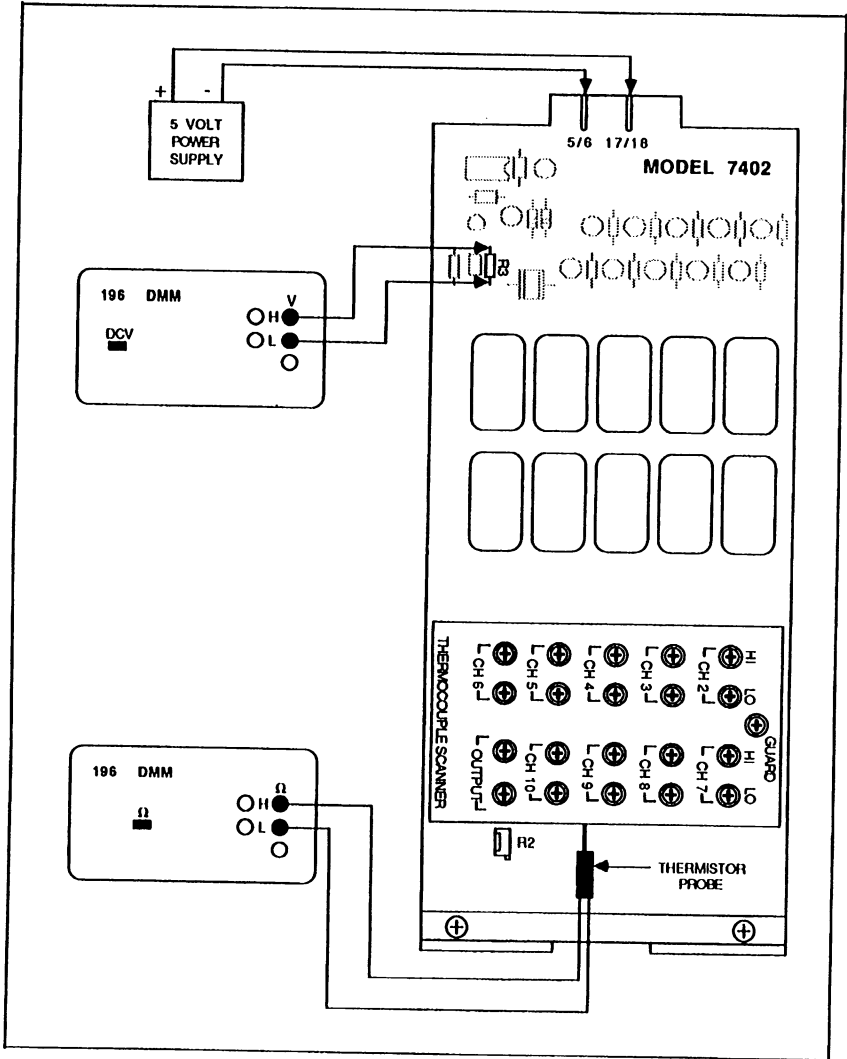

Figure 3-2. Calibration with Thermistor Probe

7. Using the following equation, calculate the equivalent reference junction output voltage (V_{REF}):

$$V_{REF} = (T_J + 273.15) * .0002$$

8. Read the voltage across R3. Ideally, it should equal the V_{REF} just calculated. Adjust trimmer R2 until the reading is within $\pm 5\mu V$ ($\pm 0.05^\circ C$).
9. Check the probe resistance again and find the corresponding temperature with the lookup tables. If the new value differs by more than $0.01^\circ C$ from the temperature found in step 6, repeat steps 7 and 8.

3.6 PERFORMANCE VERIFICATION

This procedure verifies that the card is operating within its temperature specification. Either a Model 740 or 705/706 can be used to close channel 1 of the card.

1. Turn on a Model 196 DMM and set it to the 300mVDC. Short the test leads together. Zero the DMM after the thermals have stabilized (two hours if from cold-start).
2. Set up the test equipment as shown in Figure 3-3 and let it warm up one hour. Connect the Model 7402 to the Model 740 or 705/706 through the Model 7061 Universal Adapter Card, which is used as an extender. Protect the Model 7402 from air drafts.

Use a probe with a specified accuracy of $\pm 0.005^\circ C$. The combination of the probe and reference thermometer should be accurate to $\pm 0.01^\circ C$.

3. Coat the probe with a thermally conductive compound and insert it into the hole at the rear of the cards isothermal block.
4. If using a Model 740, press the TYPE button and use the ▼ button to close the scanner card reference junction (channel 1) and display its temperature. If using a Model 705 or 706 scanner, close channel 1 from the front panel.

- Take a reading from the reference thermometer. Use the following equation to calculate the equivalent reference junction output voltage (V_{REF}):

$$V_{REF} = (T_j + 273.15) * .0002$$

- Read the voltage across the output. Compare the measured and calculated voltages. If they differ by more than $5\mu V$, perform the calibration procedure of paragraph 3.5.2.

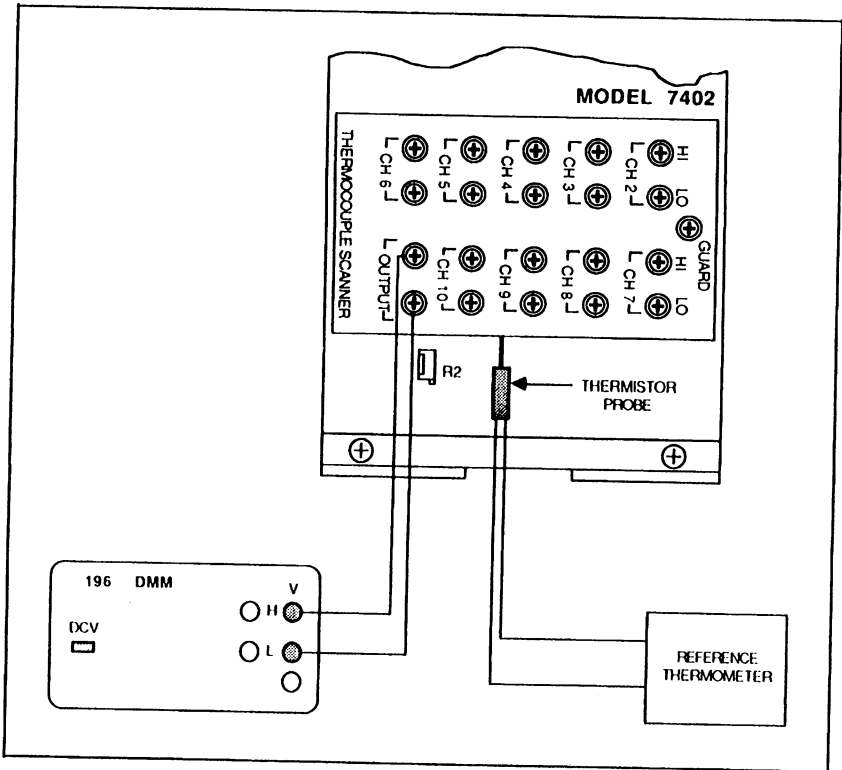

Figure 3-3. Performance Verification

3.7 ISOLATION TESTS

The two isolation tests measure leakage currents for calculating leakage resistances on the Model 7402. With the Model 7061 Universal Adapter Card, these tests can be performed faster.

If you do not have a Model 705 or 706 available, both isolation tests can be done with a Model 740 as noted in the procedures.

3.7.1 Channel Isolation

This test measures the leakage current between two channels and each channel to the output.

1. On the Model 7402, connect a copper jumper between the HI and LO terminals of the channel under test. Also short the output HI to LO. Set up the equipment as shown in Figure 3-4 for channel 2.
2. If using a Model 740, connect a continuous copper jumper among the HI and LO terminals of all channels except the channel under test.

If using a Model 705 or 706 scanner, short each of the remaining channels between HI and LO.

3. Insert the Model 7402 into a Model 740 or a Model 705/706 scanner. For a Model 740, press the TYPE button and use the ▼ button to display the temperature of the scanner card reference junction (channel 1).

For the scanners, set channel mode and select the channel under test. Program the channel under test as open and the other channels as closed.

4. Set the electrometer to amps and zero check. Program the Model 230 to output 100V. Take the electrometer out of zero check.
5. The electrometer should read less than 10^{-6} A. (Due to the capacitance of the circuit, the offset current may be high until the circuit capacitance is charged up. Wait until the readings settle out.)
6. Using Ohm's law, calculate the channel isolation (the leakage resistance between two channels). For example, $R = E/I = 100V/10^{-6}A = 10^8\Omega$.

NOTE

With the Model 617 electrometer in V/I mode, the resistance is calculated automatically.

- Put the Model 230 in standby mode and set the electrometer to zero.
- Repeat steps 2 through 7 for the remaining channels.

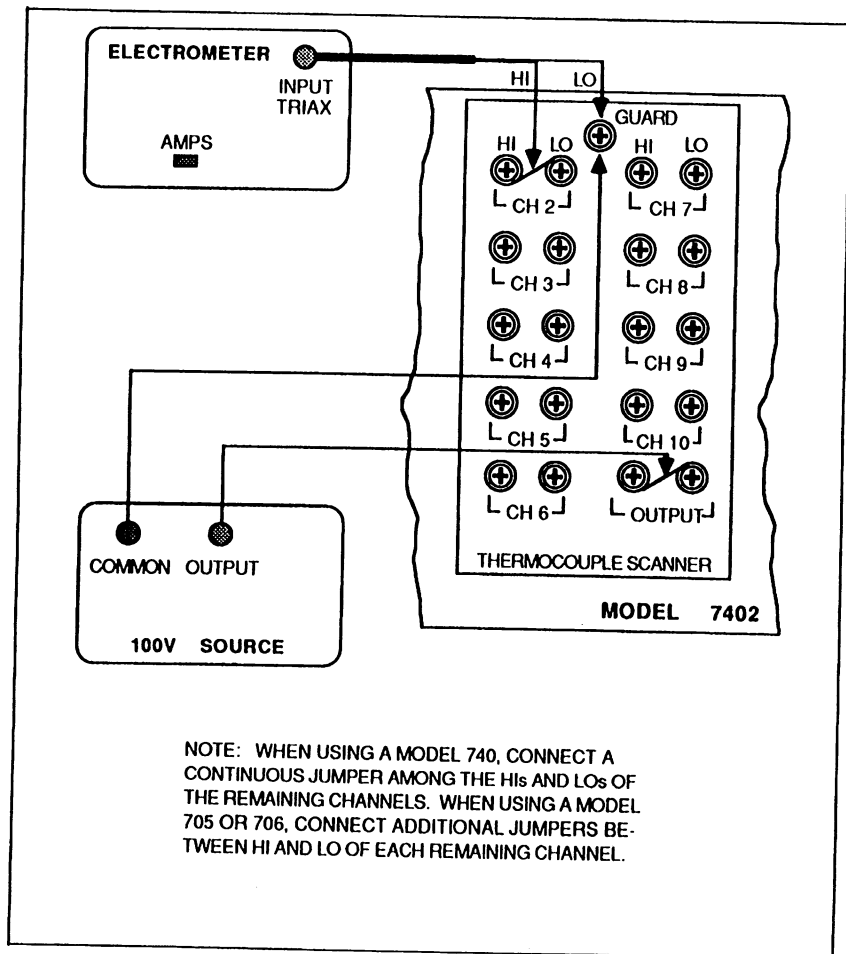

Figure 3-4. Channel Isolation

3.7.2 Input Isolation, Common Mode

This test measures the leakage current between the signal lines and shield.

1. On the Model 7402, connect a copper jumper between each channels HI and LO terminals. Also short the output HI to LO. Set up the equipment as shown in Figure 3-5 for channel 8.
2. Insert the Model 7402 into a Model 740 or a Model 705/706 scanner. For a Model 740, press the TYPE button and use the ▼ button to display the temperature of the scanner card reference junction (channel 1).

For the scanners, set channel mode and select the channel under test. Program all channels as open.

3. Set the electrometer to amps and zero check. Program the Model 230 to output 100V. Take the electrometer out of zero check.
4. The electrometer should read less than 10^{-5} A. (Due to the capacitance of the circuit, the offset current may be high until the circuit capacitance is charged up. Wait until the readings settle out.)
5. Using Ohm's law, calculate the common mode input isolation (leakage resistance). For example, $R = E/I = 100V/10^{-5}A = 10^7\Omega$.

NOTE

With the Model 617 electrometer in V/I mode, the resistance is calculated automatically.

6. Put the Model 230 in standby mode and set the electrometer to zero.
7. Repeat steps 2 through 6 for the remaining channels.

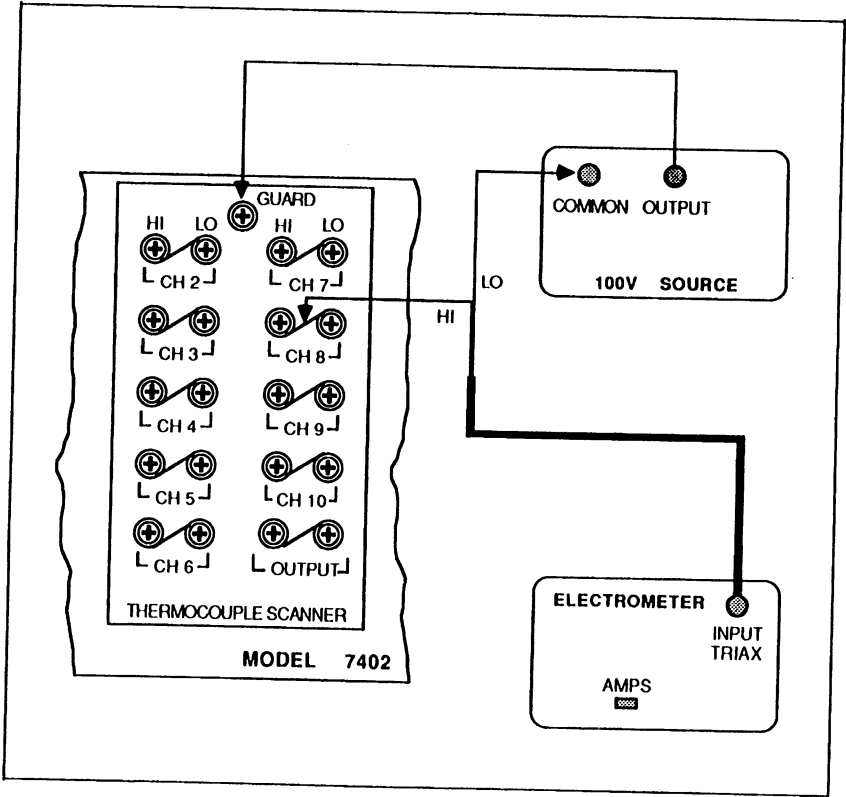

Figure 3-5. Common Mode Input Isolation

SECTION 4

REPLACEABLE PARTS

4.1 INTRODUCTION

This section contains replacement parts information, a component layout, and a schematic diagram for the Model 7402.

4.2 REPLACEABLE PARTS

Table 4-1 lists parts alphanumerically in the order of their circuit designations.

4.3 ORDERING INFORMATION

To place an order or to obtain information about replacement parts, contact your Keithley representative or the factory. See the back cover for addresses. When ordering, include the following information:

- Model number
- Serial number
- Part description
- Circuit description (if applicable)
- Keithley part number

4.4 FACTORY SERVICE

If fault can be isolated to a particular card, then it is sufficient to return just the card(s). Otherwise, send back both the card(s) and the scanner mainframe or scanning thermometer. For service, photocopy and complete the service form which follows this section and return it with the equipment.

Table 4-1. Model 7402 Parts List

Circuit Desig.	Description	Sch Loc	Keithley Part No.
C1-C13	Capacitor, 10 μ F, 25V, Aluminum Electrolytic	sev	C-314-10
C14-C16	Capacitor, .1 μ F, 50V, Ceramic	sev	C-365-.1
CR1-CR2	Diode, Silicon, 1N4148	D7	RF-28
E1	Surge Arrestor	B2	SA-2
K1-K10	Relay, 2-pole Form A	sev	RL-77
R1	Resistor, 5.62k Ω , 1%, 1/8W, Metal Film	D5	R-88-5.62k
R2	Potentiometer, 10k Ω , 10%, 1/2W, Carbon Composition	C5	RP-120-10k
R3	Resistor, 205 Ω , .1%, 1/10W, Metal Film	C6	R-263-205
R4-R13	Resistor, 270 Ω , 5%, 1/4W, Carbon Composition	sev	R-76-270
U1*	CMOS Voltage Converter, ICL7660CPA	D8	IC-287
U2	Positive Voltage Regulator, +5V, 100mA, 78L05A	D6	IC-223
U3	Temperature Transducer, AD590KH Cable Clamp Assembly, Upper Cable Clamp Assembly, Lower	D6	IC-447 7055-303-13 7055-308

*This part is static sensitive. See paragraph 3.2 for handling precautions.

4.5 COMPONENT LAYOUT AND SCHEMATIC DIAGRAM

Figure 4-1 shows a component layout of the Model 7402. Figure 4-2 shows a schematic diagram of the Model 7402.

001-207 DN 7402-100

L.T.R.	ECC NO.	REVISION	ENG.	DATE
C	11795	RELEASED		12-5-86
C1	15723	CE-9 WAS CE-15.	AS	5-4-93

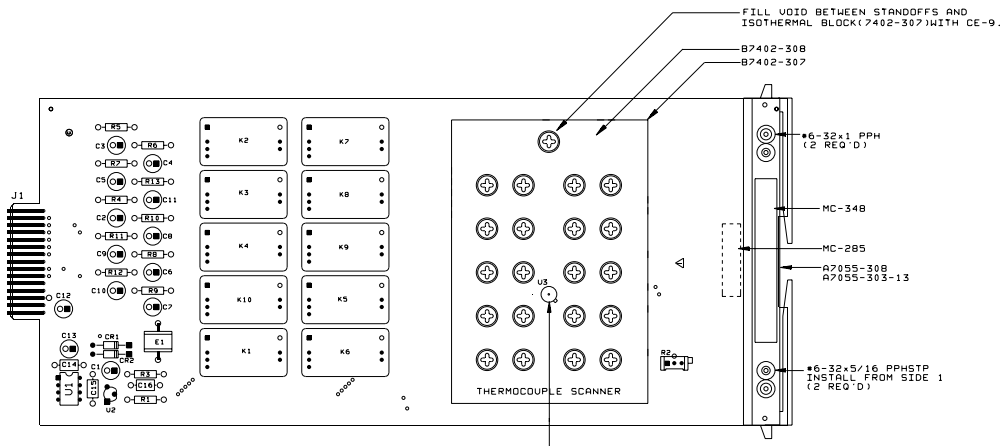

NOTE:
FOR COMPONENT INFORMATION, REFER
TO BILL OF MATERIAL (7402-000).

INSTALL U3 USING CE-12 THERMAL COMPOUND.
AFTER INSTALLATION, COVER OPENING WITH
SILICONE RTV.

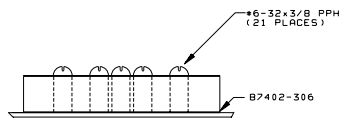

7402	1
MODEL	NEXT ASSEMBLY QTY.
USED ON	

DO NOT SCALE THIS DRAWING	DIMENSIONAL TOLERANCES UNLESS OTHERWISE SPECIFIED	DATE 11/3/86	SCALE 1:1	TITLE COMPONENT LAYOUT
XXX±.015	ANG. ±.1°	DRN. SAZ	ENG. APPR. CAC	THERMOCOUPLE SCANNER CARD
KEITHLEY KEITHLEY INSTRUMENTS INC. CLEVELAND, OHIO 44139	XXX±.005	FRAC. ±.1/64	MATERIAL	C NO. 7402-100
	SURFACE MAX. 63	FINISH		

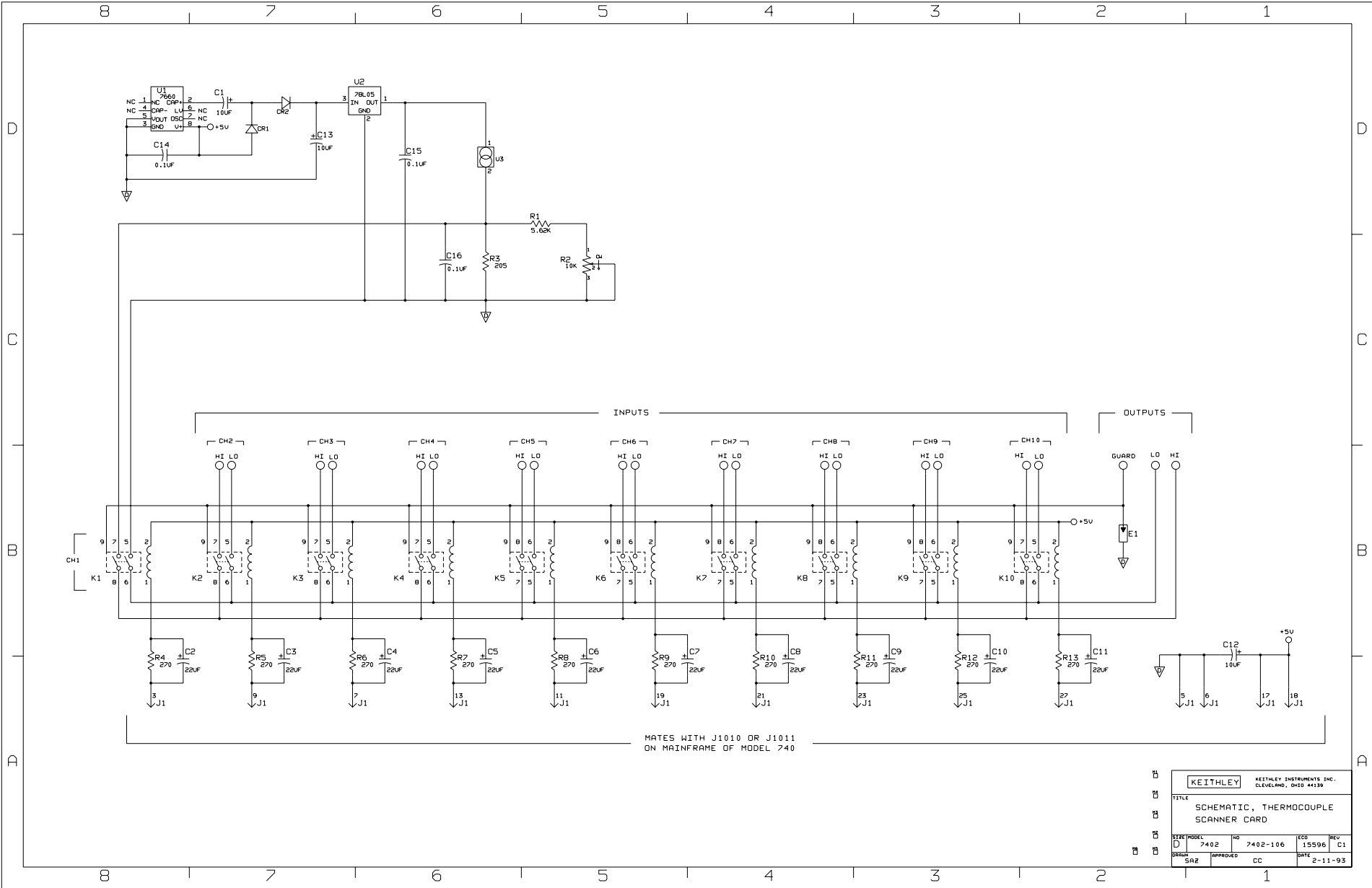

MATES WITH J1010 OR J1011
ON MAINFRAME OF MODEL 740

KEITHLEY		KEITHLEY INSTRUMENTS INC. CLEVELAND, OHIO 44139		
TITLE SCHEMATIC, THERMOCOUPLE SCANNER CARD				
SIZE	MODEL	NO	ECD	REV
D	7402	7402-106	15596	C1
DRN	SAZ	APPROVED	CC	DATE
				2-11-93



Service Form

Model No. _____ Serial No. _____ Date _____

Name and Telephone No. _____

Company _____

List all control settings, describe problem and check boxes that apply to problem. _____

- | | | |
|--|--|--|
| <input type="checkbox"/> Intermittent | <input type="checkbox"/> Analog output follows display | <input type="checkbox"/> Particular range or function bad; specify _____ |
| <input type="checkbox"/> IEEE failure | <input type="checkbox"/> Obvious problem on power-up | <input type="checkbox"/> Batteries and fuses are OK |
| <input type="checkbox"/> Front panel operational | <input type="checkbox"/> All ranges or functions are bad | <input type="checkbox"/> Checked all cables |

Display or output (check one)

- | | |
|---|--|
| <input type="checkbox"/> Drifts | <input type="checkbox"/> Unable to zero |
| <input type="checkbox"/> Unstable | <input type="checkbox"/> Will not read applied input |
| <input type="checkbox"/> Overload | |
| <input type="checkbox"/> Calibration only | <input type="checkbox"/> Certificate of calibration required |
| <input type="checkbox"/> Data required | |

(attach any additional sheets as necessary)

Show a block diagram of your measurement system including all instruments connected (whether power is turned on or not). Also, describe signal source.

Where is the measurement being performed? (factory, controlled laboratory, out-of-doors, etc.) _____

What power line voltage is used? _____ Ambient temperature? _____ °F

Relative humidity? _____ Other? _____

Any additional information. (If special modifications have been made by the user, please describe.) _____

Be sure to include your name and phone number on this service form.

KEITHLEY

Keithley Instruments, Inc.
Test Instrumentation Group
28775 Aurora Road
Cleveland, Ohio 44139

Printed in the U.S.A.